

WWW.PIONEERGROUP.COM.CN

PIONEER

STYLUS



HARBIN PIONEER M&E TECHNICAL DEVELOPMENT CO.,LTD

Company Profile

Harbin Pioneer E&E Technology Development Co., Ltd. was founded by Mr. Sun Baichun and registered in Harbin as a high-tech new technology enterprise. The company specializes in the research and development, manufacturing, sales and technical services of online measuring probes for CNC machine tools. The company has advanced processing equipment, strong technical force and exquisite processing technology.

Since its establish in 1995, we have been based on the principle of sincerity. After years of hard work, we have developed different kinds of products that is suitable for online measurement of almost all machine tools. Typical products are radio communication probe system RPS-20 and optical communication probe system OPS-30.

Pioneer's products can realize the application of workpiece alignment and inspection, tool setting and other applications. All product designs take into account the harsh working environment of CNC machine tools while ensuring high measurement accuracy.

Our products can improve the quality and productivity of your products, and we will satisfy all our customers through quality service.

In the future, the company will wholeheartedly provide new and old customers with better probe products and services, as well as competitive prices and innovative high-tech solutions.



Contents

Section 1 Stylus and the point of contact	1
Definitions of terms provided here to assist your understanding of styli and help in your selection. Ruby, silicon nitride, zirconia and high speed steel are the main materials for stylus balls, and stylus stems are mainly made of stainless steel, tungsten carbide, ceramic and carbon fiber. The stylus range includes several types: straight styli, star styli, disc styli, cylinder styli, pointer styli, stylus extension and crash protection device.	
Section 2 Technical specifications quick reference guides	5
Quick selection from our extensive range according to your requirements, such as ball diameter, overall length, and stem material.	
Section 3 Stylus naming conventions	8
An explanation of Pioneer's stylus naming conventions with illustrations of how stylus is identified by name and part number. You can easily order various standard stylus as well as custom ones just by providing stylus names or part numbers.	
Section 4 M2 threaded stylus range for use on CMM probes	9
M2 threaded styli are designed for industry standard CMM probes, and with suitable adapters, they can also fit probes of other thread sizes. Silicon nitride balls are recommended in scanning applications on aluminum, and zirconia balls are recommended in scanning applications on cast iron.	
Section 5 M3 threaded stylus range for use on CMM probes	12
M3 threaded styli are designed for CMM probes, and with suitable adapters, they can also fit probes of other thread sizes. Silicon nitride balls are recommended in scanning applications on aluminum, and zirconia balls are recommended in scanning applications on cast iron.	
Section 6 M4 threaded stylus range for use on probes for machine tools	14
M4 threaded styli are designed for machine tool applications. Pioneer provides two solutions for probing on machine tools: the EP electric probes and the TP touch probes. The EP range require electric styli with balls made of high speed steel or tungsten carbide and stems made of stainless steel or tungsten carbide, while the TP range have no particular requirements of this kind.	
Section 7 M5 threaded stylus range for use on probes for gear measuring machines	20
M5 threaded stylus are designed for gear measuring applications. Silicon nitride balls are recommended in scanning applications on aluminum, and zirconia balls are best used for scanning applications on cast iron.	
Section 8 Special ball materials	23
Silicon nitride balls are recommended in scanning applications on aluminum, and zirconia balls are best used for scanning applications on cast iron, since these two materials can avoid a phenomenon known as adhesive wear, which exists with ruby in similar applications.	
Section 9 Stylus for Faro arms	26
Specially designed stylus for use on Faro portable arm CMMs	

Stylus and the point of contact

As industry develops its requirement for precision and efficiency of part manufacture, inspection systems, especially the in-process inspection, have gain more attention. A stylus is the vital part of a measuring system which considerably affects the measurement results, so it attaches great importance to choose the right stylus for your application.

The stylus range comprise many different types, varying in size and material. This manual details Pioneer stylus range and explains the critical features of every stylus type, helping you choose the right design for each inspection need. We have used our expertise in probe and stylus design to develop a comprehensive range of CMM and machine tool styli to offer you high precision and reliable measurement data.

A stylus is the part of the measuring system which makes contact with the component, causing the probe's mechanism to displace. The generated signal enables a measurement to be taken. The feature to be inspected dictates the type and size of stylus used.

Terminology

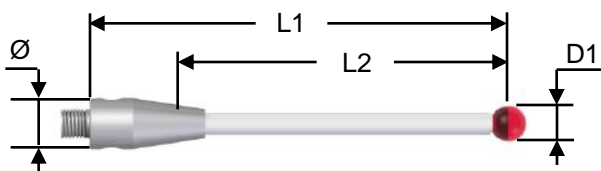

L1 Overall length	Ø =3mm (M2)
L2 Effective working length	Ø =4mm (M3)
D1 Ball diameter	Ø =7mm (M4)
	Ø =10mm (M5)

Overall length L1

It is measured from the rear mounting face of the stylus to the centre of the ball.

Effective working length L2

This is measured from the centre of the ball to the point at which the stem will foul against the feature when measuring 'normal' to the part.

Choosing a styli

To maintain the optimal accuracy we recommend that you:

1. Keep the ball as large as possible

- Maximize your ball/stem clearance to reduce the chances for false triggers caused by 'shanking out' on the stylus stem
- The larger ball reduces the effect of the surface finish of the component being inspected.

2. Keep styli short

The shorter a styli is, the less likely it bends or deflects, the higher the accuracy.

3. Minimize joints

Every time you join stylus and extensions, you introduce potential bending and deflection points. Try to keep the minimum number of pieces for your application.

Stylus material

Ruby

As one of the hardest known materials, ruby is the industry standard and the optimum stylus ball material for a vast majority of measurement applications. Synthetic ruby is 99% pure aluminum oxide which is grown into crystals (or "boules") at 2000 ° C using the Verneuil process. The boules are then cut and gradually machined into a highly spherical form. Ruby balls are exceptionally smooth on the surface, have great compressive strength and a high resistance to mechanical corrosion. Very few applications exist where ruby is not the preferred ball material, however there are two applications where balls manufactured from other materials are recommended.

The first is for heavy duty scanning applications on aluminum. Because the materials attract, a phenomenon known as 'adhesive wear' can occur which involves build up of aluminum from the surface onto the ball. A better ball material for such applications is silicon nitride.

The second is in heavy duty scanning applications on cast iron. Interaction between the two materials can result in 'abrasive wear' of the ruby ball surface. For such applications, Zirconia balls are recommended.

Silicon Nitride

Silicon nitride possesses many similar properties to ruby. It is a very hard and wear-resistant ceramic which can be machined into very high precision spheres. It can also be polished to an extremely smooth surface finish. Silicon nitride does not have the attraction to aluminum and so does not exhibit the adhesive wear seen with ruby in similar applications. However, silicon nitride does show significant abrasive wear characteristics when scanning on steel surfaces and so its applications are best confined to aluminum.

Zirconia

Zirconia is a particularly tough ceramic material with hardness and wear characteristics approaching those of ruby. Its surface properties make it an ideal material for aggressive scanning applications on cast iron components.

Bearing steel

Bearing steel offers high accuracy of size, as well as the optimum stiffness and high resistance to mechanical corrosion. It is widely used for stylus of Pioneer EP electric probes as a conductive material.

Stem material

Stainless steel

Stylus stems made of non-magnetic stainless steel are used widely for styli with ball/tip diameters of 1 mm or more and with lengths up to 30 mm. Within this range, one-piece steel stems offer the optimum stiffness to weight ratio, giving adequate ball/stem clearance without compromising stiffness with a joint between the stem and threaded body.

Tungsten carbide

Tungsten carbide stems are best used for maximizing stiffness with either small stem diameters required for ball diameters of 1 mm or below, or lengths up to 50 mm. Beyond this, weight can become a problem and stiffness is lost due to deflection at the stem to body joint.

Ceramic

For ball diameters more than 3 mm, and lengths over 30 mm, ceramic stems offer stiffness comparable to steel but are significantly lighter than tungsten carbide. Ceramic stemmed styli can also offer additional crash protection to your probe as the stem will shatter in a collision.

Carbon fiber

Carbon fiber is an inert material which weighs extremely low. Combined with a special resin matrix, it provides excellent protection in the harshest machine tool environments.

Stylus type

Straight styli



These styli are the simplest form of stylus, incorporating highly spherical industrial ruby balls and a choice of stem materials – stainless steel, tungsten carbide, ceramic and carbon fiber. They enable a vast majority of the measurement applications.

Each stylus has an effective working length (L2 in the picture on Page 1), which is the penetration that can be achieved by the ball before the stem fouls against the feature. The size of the ball and the EWL of the stylus chosen are dictated by the size of the feature to be inspected. However, keeping the stylus ball as large as possible and the stem as short as possible will ensure maximum ball/stem clearance, while providing a greater yet still rigid EWL. Using larger ruby balls also reduces the effect of the surface finish of component being inspected.

Star styli

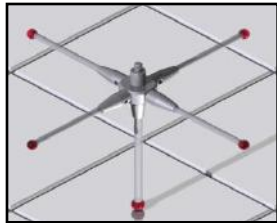

With four or five ruby ball systems mounted rigidly on a stainless steel center, these stylus clusters provide multiple-tip probing of complex features and bores. They minimize the need to move the probe to extreme points of internal features such as the sides or grooves in a bore, and therefore reduce inspection cycle times.

Each tip on a star stylus requires datuming (sometimes referred to as 'qualifying' or 'calibrating') in the same manner as a single-ball stylus. The 'span' of star styli is taken from ball center to ball center

We offer tailor-made star styli to specific customer's requirements.

Disc styli

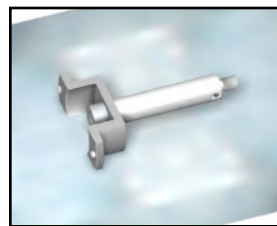

These styli are used to probe undercuts and grooves within bores which may be inaccessible to star styli. They are 'sections' of highly spherical balls and are available in various diameters and thicknesses.

Probing with the 'spherical edge' of a simple disc is effectively the same as probing on or about the equator of a large stylus ball. A simple disc requires datuming for only one diameter (usually in a ring gauge), but limits effective probing to only X and Y directions.

Cylinder styli



These are used for probing holes in thin sheet material. In addition, various threaded features can be probed and the centers of tapped holes located. Ball-ended cylinder styli allow full datuming and probing in X, Y and Z directions, thus allowing surface inspection to be performed.

Accessories and tools

In order to accommodate all the applications probes are involved in and achieve fully flexible inspection, we offer a wide range of accessories including crash protection devices, extensions, stylus knuckles, 4 and 5-way centers, stylus thread adaptors, stylus kits, etc.

Crash protection devices



Mounted between the stylus and the probe, these low-priced devices are designed to break in the event of impact and protect the probe from damage.

Stylus extensions



These provide additional probing penetration by extending the stylus away from the probe. However, using stylus extensions can reduce probe accuracy due to loss of rigidity.

Star stylus centers



These provide maximum probing flexibility with a single probe. Taking up to five styli of the same mounting thread, this accessory allows you to build stylus configurations to your own specification.

Stylus kits Refer to Section 8

Custom design service

If products listed on this manual cannot meet your requirements, we offer custom design service according to specific customer's requirements. We have expertise and experience in design, manufacturing and applications of diverse styli, and will provide you a total solution for your needs for CMM, machine tool or scanning applications.

In many application problems, the solution lies in the choice of the stylus which influences access of the workpiece features, inspections times and probe performance.

M2 styli and extensions quick reference guide *

Ruby ball / stainless steel stem

Ball diameter		1.0(0.04)	2.0(0.08)	3.0(0.12)	4.0(0.16)	5.0(0.20)	6.0(0.24)
Length	10mm	S-20-002	S-20-006	S-20-010	S-20-012	-	-
	20mm	-	-	S-20-025	S-20-027	S-20-029	S-20-031

Ruby ball / tungsten carbide stem

Ball diameter		0.5(0.02)	1.0(0.04)	2.0(0.08)	3.0(0.12)	4.0(0.16)	5.0(0.20)	6.0(0.24)
Length	10mm	S-20-052	S-20-056	-	-	-	-	-
	20mm	S-20-065	S-20-071	S-20-075	S-20-079	S-20-081	S-20-083	-
	30mm	-	S-20-101	S-20-105	S-20-109	S-20-111	S-20-113	-
	40mm	-	-	S-20-160	S-20-164	S-20-166	S-20-168	-
	50mm	-	-	-	S-20-175	S-20-177	S-20-179	-
	75mm	-	-	-	-	S-20-220	S-20-222	S-20-224
	100mm	-	-	-	-	S-20-230	S-20-232	S-20-234

Ruby ball / ceramic stem

Ball diameter		3.0(0.12)	4.0(0.16)	5.0(0.20)	6.0(0.24)
Length	30mm	S-20-120	S-20-122	S-20-125	S-20-127
	50mm	S-20-185	S-20-187	S-20-189	S-20-191

Ruby ball / carbon fiber stem

Ball diameter		4.0(0.16)	5.0(0.20)
Length	30mm	S-20-135	S-20-137
	50mm	S-20-201	S-20-203

Stylus extensions

Length	20.0(0.80)	30.0(1.19)	40.0(1.58)	50.0(1.97)
Stainless steel	S-25-110	S-25-115	S-25-120	-
Ceramic	-	S-25-125	S-25-130	S-25-135
Carbon fiber	-	-	S-25-140	S-25-145

* These are a selection of the most popular styli

M3 styli and extensions quick reference guide *

Ruby ball / tungsten carbide stem

Ball diameter	0.5(0.02)	1.0(0.04)	2.0(0.08)	3.0(0.12)	4.0(0.16)	5.0(0.20)
Length 21mm	S-30-013	S-30-001	S-30-003	S-30-005	-	-
30mm	-	-	S-30-031	S-30-037	-	-
40mm	-	-	S-30-040	S-30-046	S-30-049	S-30-052
50mm	-	-	-	S-30-055	S-30-058	S-30-061

Ruby ball / stainless steel stem

Ball diameter	4.0(0.16)	5.0(0.20)
Length 21mm	S-30-008	S-30-010
31mm	S-30-023	S-30-025

Ruby ball / ceramic stem

Ball diameter	3.0(0.12)	4.0(0.16)	5.0(0.20)
Length 50mm	S-30-066	S-30-070	S-30-075

Ruby ball / carbon fiber stem

Ball diameter	6.0(0.24)
Length 75mm	S-30-080
100mm	S-30-085

Stylus extensions

Length	20.0(0.80)	35.0(1.38)	50.0(1.97)	75.0(2.96)
Stainless steel	S-35-105	S-35-110	-	-
Ceramic	-	-	S-35-115	-
Carbon fiber	-	-	-	S-35-120

* These are a selection of the most popular styli

M4 styli and extensions quick reference guide *

Ruby ball / tungsten carbide stem

Ball diameter	1.0(0.04)	2.0(0.08)	3.0(0.12)	4.0(0.16)	5.0(0.20)	6.0(0.24)
Length 19mm	-	S-40-109	-	-	-	-
19.5mm	S-40-106	-	-	-	-	-
20mm	S-40-141	S-40-145	S-40-149	S-40-153	S-40-157	S-40-160
40mm	-	-	S-40-151	-	-	-
50mm	-	S-40-195	S-40-198	S-40-202	S-40-205	S-40-208
60mm	-	-	-	-	-	S-40-212
100mm	-	-	-	-	S-40-230	-

Ruby ball / stainless steel stem

Ball diameter	3.0(0.12)	4.0(0.16)	5.0(0.20)	6.0(0.24)
Length 10mm	-	-	S-40-103	-
18mm	S-40-113	S-40-116	S-40-119	S-40-130
20mm	-	-	S-40-123	-
30mm	-	-	S-40-125	-

Ruby ball / carbon fiber stem

Ball diameter	6.0(0.24)
Length 50mm	S-40-176
100mm	S-40-255
150mm	S-40-265

Steel ball / steel stem

Ball diameter	3.0(0.12)	4.0(0.16)	5.0(0.20)	6.0(0.24)
Length 50mm	-	S-40-164	S-40-608	-
55mm	S-40-623	-	S-40-618	-
70mm	-	-	-	S-40-213
100mm	-	-	S-40-611	-
150mm	-	-	S-40-613	-

Ruby ball / ceramic stem

Ball diameter	5.0(0.20)	6.0(0.24)
Length 50mm	S-40-173	S-40-179
75mm	S-40-220	S-40-222
100mm	S-40-240	S-40-245

Stylus extensions

Length	20.0(0.79)	30.0(1.19)	50.0(1.97)	100.0(3.94)
Stainless steel	S-45-007	S-45-009	-	-
Ceramic	-	S-45-025	S-45-028	S-45-031

* These are a selection of the most popular styli

M5 styli and extensions quick reference guide *

Ruby ball / tungsten carbide stem

Ball diameter	0.5(0.02)	1.0(0.04)	2.0(0.08)	3.0(0.12)	4.0(0.16)	5.0(0.20)
Length 20mm	S-50-007	S-50-051	S-50-059	S-50-067	S-50-071	S-50-075
30mm	S-50-017	S-50-080	S-50-086	S-50-092	S-50-095	S-50-098
40mm	-	-	S-50-112	S-50-116		
50mm	S-50-027	S-50-141	S-50-147	S-50-159	S-50-162	S-50-165
75mm	S-50-037	S-50-210	S-50-213	-	S-50-216	S-50-219
100mm	-	-	-	S-50-325	S-50-287	S-50-330

Ruby ball / carbon fiber stem

Ball diameter	6.0(0.24)
Length 50mm	S-50-175
75mm	S-50-235
100mm	S-50-310
150mm	S-50-350

Stylus extensions

Length	20.0(0.79)	30.0(1.19)	40.0(1.58)	50.0(1.97)	60.0(2.37)	80.0(3.15)	100.0(3.94)
Stainless steel	S-55-012	S-55-014		S-55-016			S-55-018
Aluminum	-			S-55-031			S-55-035
Carbon fiber	-		S-55-051	S-55-053	S-55-055	S-55-059	S-55-063

* These are a selection of the most popular styli

Stylus naming conventions

Pioneer uses the following naming convention to allow easy identification of stylus by name and part number.

A stylus name is divided into four parts: $\frac{A}{1} - \frac{AB}{2} - \frac{ABC}{3} - \frac{AB}{4}$

Part 1:

A stands for thread properties: M2, M3, M4, M5

Part 3:

A stands for ball material properties: R – ruby; S – bearing steel; C – tungsten carbide; N – silicon nitride; Z – zirconia

B stands for ball type: B – sphere; C – cylinder; D – disc; T – taper; Z – parallel hemispherical ended; H – hemisphere

C stands for the size of ball/tip (D1 in the picture on Page 1), the diameter. Such as 0.5, 1, 3, 6, and 10 (mm).

We use “-000-” in part 3 when describing an accessory, such as a stylus extension, which doesn't have a ball/tip.

The examples below show how we describe the abbreviations used following the naming convention:

Straight styli: M3-C75-RB6-S75

The above name describes an M3 threaded straight stylus with a 6 mm diameter ruby ball and a tungsten carbide stem. It has an overall length of 75 mm and an effective working length (EWL) of the same length.

Disc styli: M2-S8.6-SD18-S1.6

The above name describes an M2 threaded disc stylus with an overall length of 8.6 mm. The disc attached to the styli is made of bearing steel with a spherical diameter of 18 mm and a thickness of 1.6 mm.

Cylinder styli: M2-C15-CC1.5-S8

The above name describes an M2 threaded cylinder stylus with an overall length of 15 mm and an EWL of 8 mm. The cylindrical part used for contact inspection is made of tungsten carbide with a diameter of 1.5 mm.

Part 2:

A stands for stem material properties: S – stainless steel or bearing steel; C – tungsten carbide; P – ceramic; F – carbon fiber

B stands for stylus/accessory overall length (L1 in the picture on Page 1). Such as 10, 15.5, 21.5, 50 and 150 (mm).

Part 4:

A stands for stylus type: S – straight; T – star; TS – star styli center; E – extension; K – crash protection device

B stands for the effective working length (EWL) of stylus/accessory (L2 in the picture on Page 1). Such as 5, 8.5, 15, 36, 120 (mm).

Star styli: M2-S18-RB2-T12

The name above describes an M2 threaded star stylus fitted with a 2 mm diameter ruby ball. It has an overall length of 12 mm (from the center of the ball to the rear of the star mounting face when assembled to a probe). The span of the star cluster is 18 mm.

Extensions: M2-S30-000-E3

The name above describes an M2 threaded extension with a length of 30 mm and an attachment face diameter of 3 mm. The extension is made of stainless steel.

Accessories

Build stylus configurations to your own specification. You can easily order various accessories by providing us the part numbers.

M2 threaded stylus range

Ruby ball styli

Name	Part number	Category	Ball dia. mm(in.)	Ball material	Length L1 mm(in.)	Stem material	EWL* L2 mm(in.)
M2-S10-RB1-S4.5	S-20-002	Straight	1.0 (0.04)	Ruby	10.0 (0.39)	Stainless steel	4.5 (0.18)
M2-S10-RB2-S6	S-20-006	Straight	2.0 (0.08)	Ruby	10.0 (0.39)	Stainless steel	6.0 (0.24)
M2-S10-RB3-S7.5	S-20-010	Straight	3.0 (0.12)	Ruby	10.0 (0.39)	Stainless steel	10.0 (0.39)
M2-S10-RB4-S10	S-20-012	Straight	4.0 (0.16)	Ruby	10.0 (0.39)	Stainless steel	10.0 (0.39)
M2-S10-RB5-S10	S-20-014	Straight	5.0 (0.2)	Ruby	10.0 (0.39)	Stainless steel	10.0 (0.39)
M2-S10-RB6-S10	S-20-016	Straight	6.0 (0.24)	Ruby	10.0 (0.39)	Stainless steel	10.0 (0.39)
M2-S20-RB2-S14	S-20-021	Straight	2.0 (0.08)	Ruby	20.0 (0.79)	Stainless steel	14.0 (0.55)
M2-S20-RB3-S17.5	S-20-025	Straight	3.0 (0.12)	Ruby	20.0 (0.79)	Stainless steel	17.5 (0.69)
M2-S20-RB4-S20	S-20-027	Straight	4.0 (0.16)	Ruby	20.0 (0.79)	Stainless steel	20.0 (0.79)



Name	Part number	Category	Ball dia. mm(in.)	Ball material	Length L1 mm(in.)	Stem material	EWL* L2 mm(in.)
M2-C10-RB0.5-S3.0	S-20-052	Straight	0.5 (0.02)	Ruby	10.0 (0.39)	Tungsten carbide	3.0 (0.12)
M2-C10-RB1-S4.0	S-20-056	Straight	1.0 (0.04)	Ruby	10.0 (0.39)	Tungsten carbide	4.0 (0.16)
M2-C20-RB0.5-S7	S-20-065	Straight	0.5 (0.02)	Ruby	20.0 (0.79)	Tungsten carbide	7.0 (0.28)
M2-C20-RB1-S7	S-20-069	Straight	1.0 (0.04)	Ruby	20.0 (0.79)	Tungsten carbide	7.0 (0.28)
M2-C20-RB1-S12.5	S-20-071	Straight	1.0 (0.04)	Ruby	20.0 (0.79)	Tungsten carbide	12.5 (0.49)
M2-C20-RB2-S12	S-20-075	Straight	2.0 (0.08)	Ruby	20.0 (0.79)	Tungsten carbide	12.0 (0.47)
M2-C20-RB3-S20	S-20-079	Straight	3.0 (0.12)	Ruby	20.0 (0.79)	Tungsten carbide	20.0 (0.79)
M2-C22-RB4-S22	S-20-081	Straight	4.0 (0.16)	Ruby	22.0 (0.87)	Tungsten carbide	22.0 (0.87)
M2-C20-RB5-S20	S-20-083	Straight	5.0 (0.2)	Ruby	20.0 (0.79)	Tungsten carbide	20.0 (0.79)
M2-C27-RB1-S20.5	S-20-101	Straight	1.0 (0.04)	Ruby	27.0 (1.06)	Tungsten carbide	20.5 (0.81)
M2-C30-RB2-S22.5	S-20-105	Straight	2.0 (0.08)	Ruby	30.0 (1.18)	Tungsten carbide	22.5 (0.89)
M2-C30-RB3-S25	S-20-109	Straight	3.0 (0.12)	Ruby	30.0 (1.18)	Tungsten carbide	25.0 (0.98)
M2-C30-RB4-S30	S-20-111	Straight	4.0 (0.16)	Ruby	30.0 (1.18)	Tungsten carbide	30.0 (1.18)
M2-C30-RB5-S30	S-20-113	Straight	5.0 (0.2)	Ruby	30.0 (1.18)	Tungsten carbide	30.0 (1.18)
M2-P30-RB3-S27.5	S-20-120	Straight	3.0 (0.12)	Ruby	30.0 (1.18)	Ceramic	27.5 (1.08)
M2-P30-RB4-S30	S-20-122	Straight	4.0 (0.16)	Ruby	30.0 (1.18)	Ceramic	30.0 (1.18)
M2-P30-RB5-S30	S-20-125	Straight	5.0 (0.2)	Ruby	30.0 (1.18)	Ceramic	30.0 (1.18)
M2-P30-RB6-S30	S-20-127	Straight	6.0 (0.24)	Ruby	30.0 (1.18)	Ceramic	30.0 (1.18)

* Effective working length

M2 threaded stylus range

Name	Part number	Category	Ball dia. mm(in.)	Ball material	Length L1 mm(in.)	Stem material	EWL* L2 mm(in.)
M2-F30-RB4-S30	S-20-135	Straight	4.0 (0.16)	Ruby	30.0 (1.18)	Carbon fiber	30.0 (1.18)
M2-F30-RB5-S30	S-20-137	Straight	5.0 (0.2)	Ruby	30.0 (1.18)	Carbon fiber	30.0 (1.18)
M2-F30-RB6-S30	S-20-139	Straight	6.0 (0.24)	Ruby	30.0 (1.18)	Carbon fiber	30.0 (1.18)
M2-C40-RB2-S35	S-20-160	Straight	2.0 (0.08)	Ruby	40.0 (1.57)	Tungsten carbide	35.0 (1.38)
M2-C40-RB3-S35	S-20-164	Straight	3.0 (0.12)	Ruby	40.0 (1.57)	Tungsten carbide	35.0 (1.38)
M2-C40-RB4-S40	S-20-166	Straight	4.0 (0.16)	Ruby	40.0 (1.57)	Tungsten carbide	40.0 (1.57)
M2-C40-RB5-S40	S-20-168	Straight	5.0 (0.2)	Ruby	40.0 (1.57)	Tungsten carbide	40.0 (1.57)
M2-C50-RB3-S42.5	S-20-175	Straight	3.0 (0.12)	Ruby	50.0 (1.97)	Tungsten carbide	42.5 (1.67)
M2-C50-RB4-S50	S-20-177	Straight	4.0 (0.16)	Ruby	50.0 (1.97)	Tungsten carbide	50.0 (1.97)
M2-C50-RB5-S50	S-20-179	Straight	5.0 (0.2)	Ruby	50.0 (1.97)	Tungsten carbide	50.0 (1.97)



Name	Part number	Category	Ball dia. mm(in.)	Ball material	Length L1 mm(in.)	Stem material	EWL* L2 mm(in.)
M2-P50-RB3-S42.5	S-20-185	Straight	3.0 (0.12)	Ruby	50.0 (1.97)	Ceramic	42.5 (1.67)
M2-P50-RB4-S50	S-20-187	Straight	4.0 (0.16)	Ruby	50.0 (1.97)	Ceramic	50.0 (1.97)
M2-P50-RB5-S50	S-20-189	Straight	5.0 (0.2)	Ruby	50.0 (1.97)	Ceramic	50.0 (1.97)
M2-P50-RB6-S50	S-20-191	Straight	6.0 (0.24)	Ruby	50.0 (1.97)	Ceramic	50.0 (1.97)
M2-C75-RB4-S75	S-20-220	Straight	4.0 (0.16)	Ruby	75.0 (2.95)	Tungsten carbide	75.0 (2.95)
M2-C75-RB5-S75	S-20-222	Straight	5.0 (0.2)	Ruby	75.0 (2.95)	Tungsten carbide	75.0 (2.95)
M2-C75-RB6-S75	S-20-224	Straight	6.0 (0.24)	Ruby	75.0 (2.95)	Tungsten carbide	75.0 (2.95)
M2-C100-RB4-S100	S-20-230	Straight	4.0 (0.16)	Ruby	100.0 (3.94)	Tungsten carbide	100.0 (3.94)
M2-C100-RB5-S100	S-20-232	Straight	5.0 (0.2)	Ruby	100.0 (3.94)	Tungsten carbide	100.0 (3.94)
M2-C100-RB6-S100	S-20-234	Straight	6.0 (0.24)	Ruby	100.0 (3.94)	Tungsten carbide	100.0 (3.94)
M2-C10-RB1-TNA	S-21-102	Star	1.0 (0.04)	Ruby	10.0 (0.39)	Tungsten carbide	N/A
M2-C20-RB1-TNA	S-21-106	Star	1.0 (0.04)	Ruby	20.0 (0.79)	Tungsten carbide	N/A
M2-S18-RB2-T12	S-21-108	Star	2.0 (0.08)	Ruby	18.0 (0.71)	Tungsten carbide	12.0 (0.47)
M2-S30-RB2-T12	S-21-110	Star	2.0 (0.08)	Ruby	30.0 (1.18)	Tungsten carbide	12.0 (0.47)
M2-C10-RB1-TS4	S-21-130	Star styli center	1.0 (0.04)	Ruby	10.0 (0.39)	Tungsten carbide	4.0 (0.16)
M2-C20-RB1-TS11	S-21-134	Star styli center	1.0 (0.04)	Ruby	20.0 (0.79)	Tungsten carbide	11.0 (0.43)
M2-C20-RB2-TS12	S-21-136	Star styli center	2.0 (0.08)	Ruby	20.0 (0.79)	Tungsten carbide	12.0 (0.47)

* Effective working length

M2 threaded stylus range

Name	Part number	Category	Ball dia. mm(in.)	Ball material	Length L1 mm(in.)	Stem material	EWL* L2 mm(in.)
M2-S10-RD6-S1.2	S-22-100	Disc	6.0 (0.24)	Ruby	10.0 (0.39)	Stainless steel	1.2 (0.05)
M2-S8.6-SD18-S1.6	S-22-110	Disc	18.0 (0.71)	Bearing steel	8.6 (0.34)	Bearing steel	1.6 (0.06)
M2-S8.6-SD25-S1.6	S-22-120	Disc	25.0 (0.98)	Bearing steel	8.6 (0.34)	Bearing steel	1.6 (0.06)
M2-C11-CC1.5-S1.5	S-23-100	Cylinder	1.5 (0.06)	Tungsten carbide	11.0 (0.43)	Tungsten carbide	1.5 (0.06)
M2-C13-CC3-S3.8	S-23-105	Cylinder	3.0 (0.12)	Tungsten carbide	13.0 (0.51)	Tungsten carbide	3.8 (0.15)



Name	Part number	Category	Ball dia. mm(in.)	Ball material	Length L1 mm(in.)	Stem material	EWL* L2 mm(in.)
M2-C16-CZ1.5-S8	S-24-115	Parallel hemispherical ended	1.5 (0.06)	Tungsten carbide	16.0 (0.63)	Tungsten carbide	8.0 (0.31)
M2-C16-CZ2-S8.5	S-24-120	Parallel hemispherical ended	2.0 (0.08)	Tungsten carbide	16.0 (0.63)	Tungsten carbide	8.5 (0.33)
M2-C40-CZ2-S32	S-24-125	Parallel hemispherical ended	2.0 (0.08)	Tungsten carbide	40.0 (1.57)	Tungsten carbide	32.0 (1.26)
M2-C22.5-CZ3-S22.5	S-24-130	Parallel hemispherical ended	3.0 (0.12)	Tungsten carbide	22.5 (0.89)	Tungsten carbide	22.5 (0.89)
M2-S20-000-E3	S-25-110	Extension	---	---	20.0 (0.79)	Stainless steel	---
M2-S30-000-E3	S-25-115	Extension	---	---	30.0 (1.18)	Stainless steel	---
M2-S40-000-E3	S-25-120	Extension	---	---	40.0 (1.57)	Stainless steel	---
M2-P30-000-E3	S-25-125	Extension	---	---	30.0 (1.18)	Ceramic	---
M2-P50-000-E3	S-25-135	Extension	---	---	50.0 (1.97)	Ceramic	---
M2-F40-000-E3	S-25-140	Extension	---	---	40.0 (1.57)	Carbon fiber	---
M2-F50-000-E3	S-25-145	Extension	---	---	50.0 (1.97)	Carbon fiber	---



M3 threaded stylus range

Ruby ball styli

Name	Part number	Category	Ball dia. mm(in.)	Ball material	Length L1 mm(in.)	Stem material	EWL* L2 mm(in.)
M3-C21-RB0.5-S2	S-30-013	Straight	0.5 (0.02)	Ruby	21.0 (0.83)	Tungsten carbide	2.0 (0.08)
M3-C21-RB1-S4	S-30-001	Straight	1.0 (0.04)	Ruby	21.0 (0.83)	Tungsten carbide	4.0 (0.16)
M3-C21-RB2-S8	S-30-003	Straight	2.0 (0.08)	Ruby	21.0 (0.83)	Tungsten carbide	8.0 (0.31)
M3-C21-RB3-S12	S-30-005	Straight	3.0 (0.12)	Ruby	21.0 (0.83)	Tungsten carbide	12.0 (0.47)
M3-S21-RB4-S17.2	S-30-008	Straight	4.0 (0.16)	Ruby	21.0 (0.83)	Stainless Steel	17.2 (0.68)
M3-S21-RB5-S21	S-30-010	Straight	5.0 (0.2)	Ruby	21.0 (0.83)	Stainless Steel	21.0 (0.83)
M3-C30-RB2-S22.5	S-30-031	Straight	2.0 (0.08)	Ruby	30.0 (1.18)	Tungsten carbide	22.5 (0.89)
M3-C30-RB3-S22.5	S-30-037	Straight	3.0 (0.12)	Ruby	30.0 (1.18)	Tungsten carbide	22.5 (0.89)
M3-S31-RB4-S27	S-30-023	Straight	4.0 (0.16)	Ruby	31.0 (1.22)	Stainless steel	27.0 (1.06)
M3-S31-RB5-S31	S-30-025	Straight	5.0 (0.2)	Ruby	30.0 (1.18)	Stainless steel	31.0 (1.22)



Name	Part number	Category	Ball dia. mm(in.)	Ball material	Length L1 mm(in.)	Stem material	EWL* L2 mm(in.)
M3-C40-RB2-S32.5	S-30-040	Straight	2.0 (0.08)	Ruby	40.0 (1.57)	Tungsten carbide	32.5 (1.28)
M3-C40-RB3-S32.5	S-30-046	Straight	3.0 (0.12)	Ruby	40.0 (1.57)	Tungsten carbide	32.5 (1.28)
M3-C40-RB4-S36	S-30-049	Straight	4.0 (0.16)	Ruby	40.0 (1.57)	Tungsten carbide	36.0 (1.42)
M3-C40-RB5-S40	S-30-052	Straight	5.0 (0.2)	Ruby	40.0 (1.57)	Tungsten carbide	40.0 (1.57)
M3-C50-RB3-S42.5	S-30-055	Straight	3.0 (0.12)	Ruby	50.0 (1.97)	Tungsten carbide	42.5 (1.67)
M3-C50-RB4-S46	S-30-058	Straight	4.0 (0.16)	Ruby	50.0 (1.97)	Tungsten carbide	46.0 (1.81)
M3-C50-RB5-S50	S-30-061	Straight	5.0 (0.2)	Ruby	50.0 (1.97)	Tungsten carbide	50.0 (1.97)
M3-P50-RB3-S42.5	S-30-066	Straight	3.0 (0.12)	Ruby	50.0 (1.97)	Ceramic	42.5 (1.67)
M3-P50-RB4-S46	S-30-070	Straight	4.0 (0.16)	Ruby	50.0 (1.97)	Ceramic	46.0 (1.81)
M3-P50-RB5-S50	S-30-075	Straight	5.0 (0.2)	Ruby	50.0 (1.97)	Ceramic	50.0 (1.97)
M3-F75-RB6-S75	S-30-080	Straight	6.0 (0.24)	Ruby	75.0 (2.95)	Carbon fiber	75.0 (2.95)
M3-F100-RB6-S100	S-30-085	Straight	6.0 (0.24)	Ruby	100.0 (3.94)	Carbon fiber	100.0 (3.94)



* Effective working length

M3 threaded stylus range

Name	Part number	Category	Ball dia. mm(in.)	Ball material	Length L1 mm(in.)	Stem material	EWL* L2 mm(in.)
M3-S20-000-E4	S-35-105	Extension	---	---	20.0(0.79)	Stainless steel	---
M3-S35-000-E4	S-35-110	Extension	---	---	35.0(1.38)	Stainless steel	---
M3-P50-000-E4	S-35-115	Extension	---	---	50.0(1.97)	Ceramic	---
M3-F75-000-E4	S-35-120	Extension	---	---	75.0(2.95)	Carbon fiber	---
M3-F100-000-E4	S-35-125	Extension	---	---	100.0(3.94)	Carbon fiber	---



Name	Part number	Category	Ball dia. mm(in.)	Ball material	Length L1 mm(in.)	Stem material	EWL* L2 mm(in.)
M3-S30-SD12.7-S2.3	S-32-110	Disc	12.7(0.5)	Bearing steel	30.0(1.18)	Bearing steel	2.3(0.09)
M3-S7-SD35-S5	S-32-115	Disc	35.0(1.38)	Bearing steel	6.0(0.24)	Bearing steel	5.0(0.2)
M3-C30-RB2-T11	S-31-110	Star	2.0(0.08)	Ruby	30.0(1.18)	Tungsten carbide	11.0(0.43)
M3-C50-RB2-T21	S-31-115	Star	2.0(0.08)	Ruby	50.0(1.97)	Tungsten carbide	21.0(0.83)



* Effective working length

M4 threaded stylus range

Ruby ball styli

Name	Part number	Category	Ball dia. mm(in.)	Ball material	Length L1 mm(in.)	Stem material	EWL* L2 mm(in.)
M4-S10.5-RB5-S5.5	S-40-103	Straight	5.0(0.2)	Ruby	10.5(0.41)	Stainless steel	5.5(0.22)
M4-S19.5-RB1-S4	S-40-106	Straight	1.0(0.04)	Ruby	19.5(0.77)	Tungsten carbide	4.0(0.160)
M4-S19-RB2-S8	S-40-109	Straight	2.0(0.08)	Ruby	19.0(0.75)	Tungsten carbide	8.0(0.31)
M4-S18.5-RB3-S13	S-40-113	Straight	3.0(0.12)	Ruby	18.5(0.73)	Stainless steel	13.0(0.51)
M4-S18-RB4-S13	S-40-116	Straight	4.0(0.16)	Ruby	18.0(0.71)	Stainless steel	13.0(0.51)
M4-S18-RB5-S13.5	S-40-119	Straight	5.0(0.2)	Ruby	18.0(0.71)	Stainless steel	13.5(0.53)
M4-S17.5-RB6-S13.5	S-40-130	Straight	5.0(0.2)	Ruby	17.5(0.69)	Stainless steel	13.5(0.53)
M4-S20-RB5-S16	S-40-123	Straight	5.0(0.2)	Ruby	20.0(0.79)	Stainless steel	16.0(0.63)
M4-S30-RB5-S26	S-40-125	Straight	5.0(0.2)	Ruby	30.0(1.18)	Stainless steel	26.0(1.02)
M4-S50-RB5-S35	S-40-170	Straight	5.0(0.2)	Ruby	50.0(1.97)	Stainless steel	35.0(1.38)
M4-S70-RB6-S60	S-40-131	Straight	5.0(0.2)	Ruby	70.0(2.76)	Stainless steel	60.0(2.36)
M4-S90-RB6-S80	S-40-132	Straight	5.0(0.2)	Ruby	90.0(3.54)	Stainless steel	80.0(3.15)
M4-S110-RB6-S100	S-40-133	Straight	5.0(0.2)	Ruby	110.0(4.33)	Stainless steel	100.0(3.94)



Name	Part number	Category	Ball dia. mm(in.)	Ball material	Length L1 mm(in.)	Stem material	EWL* L2 mm(in.)
M4-C20-RB1-S10	S-40-141	Straight	1.0(0.04)	Ruby	20.0(0.79)	Tungsten carbide	10.0(0.39)
M4-C20-RB2-S10	S-40-145	Straight	2.0(0.08)	Ruby	20.0(0.79)	Tungsten carbide	10.0(0.39)
M4-C30-RB2-S20	S-40-146	Straight	2.0(0.08)	Ruby	30.0(1.18)	Tungsten carbide	20.0(0.79)
M4-C50-RB2-S40	S-40-195	Straight	2.0(0.08)	Ruby	50.0(1.97)	Tungsten carbide	40.0(1.57)
M4-C20-RB3-S10	S-40-149	Straight	3.0(0.12)	Ruby	20.0(0.79)	Tungsten carbide	10.0(0.39)
M4-C30-RB3-S20	S-40-150	Straight	3.0(0.12)	Ruby	30.0(1.18)	Tungsten carbide	20.0(0.79)
M4-C40-RB3-S30	S-40-151	Straight	3.0(0.12)	Ruby	40.0(1.57)	Tungsten carbide	30.0(1.18)
M4-C50-RB3-S38	S-40-198	Straight	3.0(0.12)	Ruby	50.0(1.97)	Tungsten carbide	38.0(1.5)
M4-C20-RB4-S10	S-40-153	Straight	4.0(0.16)	Ruby	20.0(0.79)	Tungsten carbide	10.0(0.39)
M4-C50-RB4-S38	S-40-202	Straight	4.0(0.16)	Ruby	50.0(1.97)	Tungsten carbide	38.0(1.5)
M4-C20-RB5-S6	S-40-157	Straight	5.0(0.2)	Ruby	20.0(0.79)	Tungsten carbide	6.0(0.24)
M4-C50-RB5-S36	S-40-205	Straight	5.0(0.2)	Ruby	50.0(1.97)	Tungsten carbide	36.0(1.42)

* Effective working length

M4 threaded stylus range

Name	Part number	Category	Ball dia. mm(in.)	Ball material	Length L1 mm(in.)	Stem material	EWL* L2 mm(in.)
M4-C100-RB5-S85	S-40-230	Straight	5.0(0.2)	Ruby	100.0(3.94)	Tungsten carbide	85.0(3.35)
M4-C150-RB5-S133	S-40-235	Straight	5.0(0.2)	Ruby	150.0(5.91)	Tungsten carbide	133.0(5.24)
M4-C20-RB6-S6	S-40-160	Straight	6.0(0.24)	Ruby	20.0(0.79)	Stainless steel	6.0(0.24)
M4-C50-RB6-S36	S-40-208	Straight	6.0(0.24)	Ruby	50.0(1.97)	Stainless steel	36.0(1.42)
M4-P50-RB5-S34	S-40-173	Straight	5.0(0.2)	Ruby	50.0(1.97)	Ceramic	34.0(1.34)
M4-P75-RB5-S59	S-40-220	Straight	5.0(0.2)	Ruby	75.0(2.95)	Ceramic	59.0(2.32)
M4-P100-RB5-S84	S-40-240	Straight	5.0(0.2)	Ruby	100.0(3.94)	Ceramic	84.0(3.31)
M4-F50-RB6-S36	S-40-176	Straight	6.0(0.24)	Ruby	50.0(1.97)	Carbon fiber	36.0(1.42)
M4-P50-RB6-S36	S-40-179	Straight	6.0(0.24)	Ruby	50.0(1.97)	Ceramic	36.0(1.42)
M4-P60-RB6-S46	S-40-180	Straight	6.0(0.24)	Ruby	60.0(2.36)	Ceramic	46.0(1.81)
M4-P75-RB6-S63	S-40-222	Straight	6.0(0.24)	Ruby	75.0(2.95)	Ceramic	63.0(2.48)
M4-P80-RB6-S68	S-40-223	Straight	6.0(0.24)	Ruby	80.0(3.15)	Ceramic	68.0(2.68)
M4-P100-RB6-S86	S-40-245	Straight	6.0(0.24)	Ruby	100.0(3.94)	Ceramic	86.0(3.39)
M4-F100-RB6-S86	S-40-255	Straight	6.0(0.24)	Ruby	100.0(3.94)	Carbon fiber	86.0(3.39)
M4-F120-RB6-S106	S-40-257	Straight	6.0(0.24)	Ruby	120.0(4.72)	Carbon fiber	106.0(4.17)

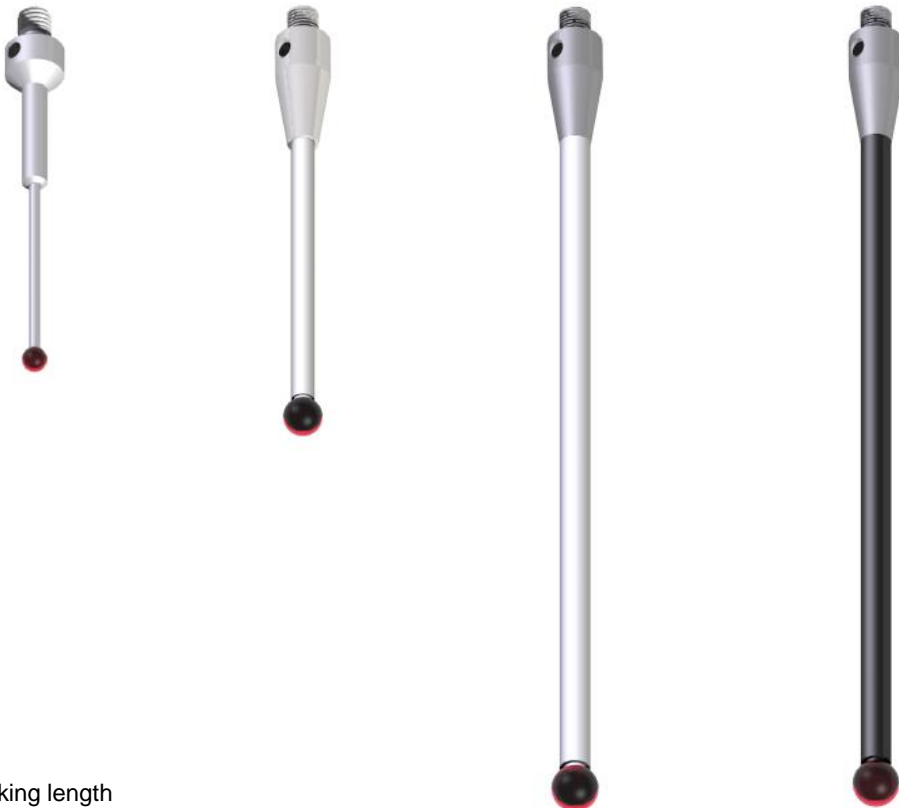

* Effective working length

M4 threaded stylus range

Steel ball styli

Name	Part number	Category	Ball dia. mm(in.)	Ball material	Length L1 mm(in.)	Stem material	EWL* L2 mm(in.)
M4-C30-SB2-S20	S-40-602	Straight	2.0(0.08)	Bearing steel	30.0(1.18)	Tungsten carbide	20.0(0.79)
M4-C40-SB3-S28	S-40-605	Straight	3.0(0.12)	Bearing steel	40.0(1.57)	Tungsten carbide	30.0(1.18)
M4-S55-SB3-S25	S-40-623	Straight	3.0(0.12)	Bearing steel	55.0(2.17)	Stainless steel	25.0(0.98)
M4-C50-SB4-S36	S-40-609	Straight	4.0(0.16)	Bearing steel	50.0(1.97)	Tungsten carbide	36.0(1.42)
M4-S50-SB4-S36	S-40-610	Straight	4.0(0.16)	Bearing steel	50.0(1.97)	Stainless steel	36.0(1.42)
M4-S50-SB5-S32	S-40-608	Straight	5.0(0.2)	Bearing steel	50.0(1.97)	Stainless steel	32.0(1.26)
M4-S54-SB5-S50	S-40-618	Straight	5.0(0.2)	Bearing steel	54.0(2.13)	Stainless steel	50.0(1.97)
M4-S100-SB5-S85	S-40-611	Straight	5.0(0.2)	Bearing steel	100.0(3.94)	Stainless steel	85.0(3.35)
M4-S150-SB5-S120	S-40-613	Straight	5.0(0.2)	Bearing steel	150.0(5.91)	Stainless steel	120.0(4.72)
M4-S70-SB6-S58.5	S-40-628	Straight	6.0(0.24)	Bearing steel	70.0(2.76)	Stainless steel	58.5(2.3)
M4-S100-SB6-S88.5	S-40-632	Straight	6.0(0.24)	Bearing steel	100.0(3.94)	Stainless steel	88.5(3.48)



* Effective working length

M4 threaded stylus range

Star stylus centers

Part number		S-41-130 Ceramic	S-41-140 Ceramic
D1	Ball dia.mm(in.)	6.0(0.24)	6.0(0.24)
L1	Length mm(in.)	50.0(1.97)	100.0(3.94)
L2	Length mm(in.)	36.0(1.42)	86.0(3.39)

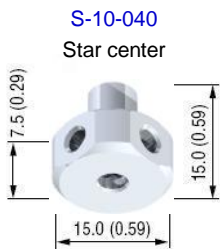

Disc styli

Part number	S-42-110 Bearing steel	S-42-111 Bearing steel	S-42-112 Bearing steel
Dia. A mm(in.)	Ø30.0(1.19)	Ø35.0(1.38)	Ø50.0(1.97)
Dia. B mm(in.)	Ø21.0(0.83)	Ø21.0(0.83)	Ø23.0(0.91)
C mm(in.)	2.2(0.09)	2.2(0.09)	3.0(0.12)
D mm(in.)	3.0(0.12)	3.0(0.12)	4.0(0.16)

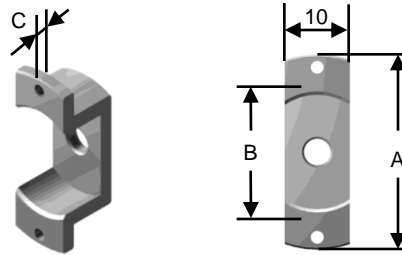

Swivel adapter

Part number	S-10-015 Stainless steel	S-10-020 Stainless steel
Length A mm(in.)	10.0(0.40)	13.5(0.54)
Length B mm(in.)	12.5(0.50)	16.0(0.63)

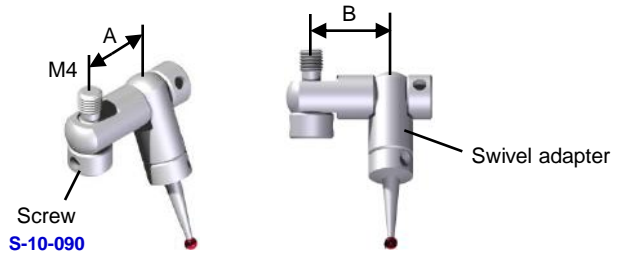

Styli crank

Part number	S-10-025 Stainless steel	S-10-030 Stainless steel
Length A mm(in.)	21.9(0.86)	27.6(1.09)

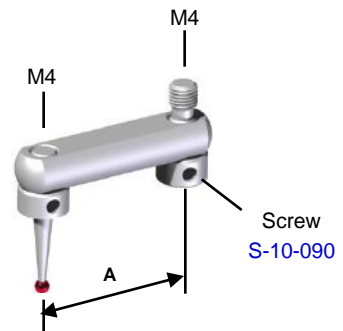

M4 threaded stylus range

Crash protection device

Part number	S-11-001	S-11-002	S-11-003	S-11-005	S-11-006	S-11-012	S-11-015	S-11-010
Length mm(in.)	6.0(0.24)	8.0(0.32)	8.0(0.32)	12.0(0.48)	15.2(0.60)	13.5(0.53)	19.0(0.75)	22.3(0.88)
Fit for Pioneer probes	TP400			TP300				
				TP60				
				OPS-10				
				EP600				



Name	Part number	Category	Ball dia. mm(in.)	Ball material	Length L1 mm(in.)	Stem material	EWL* L2 mm(in.)
M4-S10-000-E7	S-45-003	Extension	---	---	10.0(0.39)	Stainless steel	---
M4-S15-000-E7	S-45-005	Extension	---	---	15.0(0.59)	Stainless steel	---
M4-S20-000-E7	S-45-007	Extension	---	---	20.0(0.79)	Stainless steel	---
M4-S30-000-E7	S-45-009	Extension	---	---	30.0(1.18)	Stainless steel	---
M4-P30-000-E7	S-45-025	Extension	---	---	30.0(1.18)	Ceramic	---
M4-P50-000-E7	S-45-028	Extension	---	---	50.0(1.97)	Ceramic	---
M4-P100-000-E7	S-45-031	Extension	---	---	100.0(3.94)	Ceramic	---



* Effective working length

M4 threaded stylus range

Ruby ball styli

Name	Part number	Category	Ball dia. mm(in.)	Ball material	Length L1 mm(in.)	Stem material	EWL* L2 mm(in.)
M5-C20-RB0.5-S4	S-50-007	Straight	0.5(0.02)	Ruby	20.0(0.79)	Tungsten carbide	4.0(0.16)
M5-C30-RB0.5-S4	S-50-017	Straight	0.5(0.02)	Ruby	30.0(1.18)	Tungsten carbide	4.0(0.16)
M5-C50-RB0.5-S4	S-50-027	Straight	0.5(0.02)	Ruby	50.0(1.97)	Tungsten carbide	4.0(0.16)
M5-C75-RB0.5-S4	S-50-037	Straight	0.5(0.02)	Ruby	75.0(2.95)	Tungsten carbide	4.0(0.16)



Name	Part number	Category	Ball dia. mm(in.)	Ball material	Length L1 mm(in.)	Stem material	EWL* L2 mm(in.)
M5-C20-RB1-S5	S-50-051	Straight	1.0(0.04)	Ruby	20.0(0.79)	Tungsten carbide	5.0(0.2)
M5-C20-RB2-S11	S-50-059	Straight	2.0(0.08)	Ruby	20.0(0.79)	Tungsten carbide	11.0(0.43)
M5-C20-RB3-S11	S-50-067	Straight	3.0(0.12)	Ruby	20.0(0.79)	Tungsten carbide	11.0(0.43)
M5-C20-RB4-S11	S-50-071	Straight	4.0(0.16)	Ruby	20.0(0.79)	Tungsten carbide	11.0(0.43)
M5-C20-RB5-S11	S-50-075	Straight	5.0(0.2)	Ruby	20.0(0.79)	Tungsten carbide	11.0(0.43)



Name	Part number	Category	Ball dia. mm(in.)	Ball material	Length L1 mm(in.)	Stem material	EWL* L2 mm(in.)
M5-C30-RB1-S5	S-50-080	Straight	1.0(0.04)	Ruby	30.0(1.18)	Tungsten carbide	5.0(0.2)
M5-C30-RB2-S21	S-50-086	Straight	2.0(0.08)	Ruby	30.0(1.18)	Tungsten carbide	21.0(0.83)
M5-C30-RB3-S21	S-50-092	Straight	3.0(0.12)	Ruby	30.0(1.18)	Tungsten carbide	21.0(0.83)
M5-C30-RB4-S21	S-50-095	Straight	4.0(0.16)	Ruby	30.0(1.18)	Tungsten carbide	21.0(0.83)
M5-C30-RB5-S21	S-50-098	Straight	5.0(0.2)	Ruby	30.0(1.18)	Tungsten carbide	21.0(0.83)



M5 threaded stylus range

Name	Part number	Category	Ball dia. mm(in.)	Ball material	Length L1 mm(in.)	Stem material	EWL* L2 mm(in.)
M5-C40-RB2-S31	S-50-112	Straight	2.0(0.08)	Ruby	40.0(1.58)	Tungsten carbide	31.0(1.23)
M5-C40-RB3-S31	S-50-116	Straight	3.0(0.12)	Ruby	40.0(1.58)	Tungsten carbide	31.0(1.23)
M5-C50-RB1-S5	S-50-141	Straight	1.0(0.04)	Ruby	50.0(1.97)	Tungsten carbide	5.0(0.20)
M5-C50-RB2-S41	S-50-147	Straight	2.0(0.08)	Ruby	50.0(1.97)	Tungsten carbide	41.0(1.61)
M5-C50-RB2-S5	S-50-150	Straight	2.0(0.08)	Ruby	50.0(1.97)	Tungsten carbide	5.0(0.2)
M5-C50-RB3-S41	S-50-159	Straight	3.0(0.12)	Ruby	50.0(1.97)	Tungsten carbide	41.0(1.61)
M5-C50-RB4-S41	S-50-162	Straight	4.0(0.16)	Ruby	50.0(1.97)	Tungsten carbide	41.0(1.61)
M5-C50-RB5-S41	S-50-165	Straight	5.0(0.2)	Ruby	50.0(1.97)	Tungsten carbide	41.0(1.61)
M5-F50-RB6-S39	S-50-175	Straight	6.0(0.24)	Ruby	50.0(1.97)	Carbon fiber	39.0(1.54)



Name	Part number	Category	Ball dia. mm(in.)	Ball material	Length L1 mm(in.)	Stem material	EWL* L2 mm(in.)
M5-C75-RB1-S5	S-50-210	Straight	1.0(0.04)	Ruby	75.0(2.95)	Tungsten carbide	5.0(0.2)
M5-C75-RB2-S6	S-50-213	Straight	2.0(0.08)	Ruby	75.0(2.95)	Tungsten carbide	6.0(0.24)
M5-C75-RB4-S65	S-50-216	Straight	4.0(0.16)	Ruby	75.0(2.95)	Tungsten carbide	65.0(2.56)
M5-C75-RB5-S65	S-50-219	Straight	5.0(0.2)	Ruby	75.0(2.95)	Tungsten carbide	65.0(2.56)
M5-F75-RB6-S64	S-50-235	Straight	6.0(0.24)	Ruby	75.0(2.95)	Carbon fiber	65.0(2.56)



* Effective working length

M5 threaded stylus range

Name	Part number	Category	Ball dia. mm(in.)	Ball material	Length L1 mm(in.)	Stem material	EWL* L2 mm(in.)
M5-C100-RB3-S20	S-50-281	Straight	3.0(0.12)	Ruby	100.0(3.94)	Tungsten carbide	20.0(0.79)
M5-C100-RB4-S20	S-50-284	Straight	4.0(0.16)	Ruby	100.0(3.94)	Tungsten carbide	20.0(0.79)
M5-C100-RB3-S55	S-50-325	Straight	3.0(0.12)	Ruby	100.0(3.94)	Tungsten carbide	55.0(2.17)
M5-C100-RB4-S50	S-50-287	Straight	4.0(0.16)	Ruby	100.0(3.94)	Tungsten carbide	50.0(1.97)
M5-C100-RB5-S50	S-50-290	Straight	5.0(0.2)	Ruby	100.0(3.94)	Tungsten carbide	50.0(1.97)
M5-F100-RB6-S50	S-50-310	Straight	6.0(0.24)	Ruby	100.0(3.94)	Carbon fiber	50.0(1.97)
M5-C100-RB5-S91	S-50-330	Straight	5.0(0.2)	Ruby	100.0(3.94)	Tungsten carbide	91.0(3.58)
M5-F100-RB6-S80	S-50-335	Straight	6.0(0.24)	Ruby	100.0(3.94)	Carbon fiber	80.0(3.15)



Name	Part number	Category	Ball dia. mm(in.)	Ball material	Length L1 mm(in.)	Stem material	EWL* L2 mm(in.)
M5-F150-RB6-S130	S-50-350	Straight	6.0(0.24)	Ruby	150.0(5.91)	Carbon fiber	130.0(5.12)
M5-F200-RB6-S180	S-50-365	Straight	6.0(0.24)	Ruby	200.0(7.87)	Carbon fiber	180.0(7.09)
M5-F300-RB6-S280	S-50-380	Straight	6.0(0.24)	Ruby	300.0(11.81)	Carbon fiber	280.0(11.02)



Name	Part number	Category	Ball dia. mm(in.)	Ball material	Length L1 mm(in.)	Stem material	EWL* L2 mm(in.)
M5-S20-000-E10	S-55-012	Extension	---	---	20.0(0.79)	Stainless steel	---
M5-S30-000-E10	S-55-014	Extension	---	---	30.0(1.18)	Stainless steel	---
M5-S50-000-E10	S-55-016	Extension	---	---	50.0(1.97)	Stainless steel	---
M5-S100-000-E10	S-55-018	Extension	---	---	100.0(3.94)	Stainless steel	---



M5 threaded stylus range

Name	Part number	Category	Ball dia. mm(in.)	Ball material	Length L1 mm(in.)	Stem material	EWL* L2 mm(in.)
M5-A50-000-E20	S-55-031	Extension	---	---	50.0(1.97)	Aluminum alloy	---
M5-A100-000-E20	S-55-035	Extension	---	---	100.0(3.94)	Aluminum alloy	---
M5-A200-000-E20	S-55-039	Extension	---	---	200.0(7.87)	Aluminum alloy	---



Name	Part number	Category	Ball dia. mm(in.)	Ball material	Length L1 mm(in.)	Stem material	EWL* L2 mm(in.)
M5-S5-SD12-S3	S-52-010	Disc	12.0(0.47)	Bearing steel	5.0(0.2)	Bearing steel	3.0(0.12)
M5-S5-SD21-S3	S-52-015	Disc	21.0(0.83)	Bearing steel	5.0(0.2)	Bearing steel	3.0(0.12)
M5-S8-SD35-S5	S-52-020	Disc	35.0(1.38)	Bearing steel	8.0(0.31)	Bearing steel	5.0(0.2)
M5-S8-SD63.5-S5	S-52-025	Disc	63.0(2.48)	Bearing steel	8.0(0.31)	Bearing steel	5.0(0.2)



Stylus tools

[S-10-201](#)

For M2 and M3 threaded stylus



[S-10-202](#)

For M4 threaded stylus



[S-10-203](#)

For M5 threaded stylus



Special ball materials: silicon nitride & zirconia

Contact scanning applications involve sliding a hard stylus ball over various surface materials to collect measurements. In the absence of any lubrication, the form of the stylus ball can be altered through material pick-up from the surface, or through wear. This can result in errors in measurement data.

The extent of this alteration depends on the material properties of both the stylus ball and the surface, as well as the contact force, scan distance and contact distribution over the surface of the ball.

The first is for heavy duty scanning applications (not including trigger touch applications) on aluminum. Because the materials attract, a phenomenon known as 'adhesive wear' can occur; this involves the build up of aluminum from the surface on the ball. A better ball material for such applications is silicon nitride.

The second application where ruby may be problematic is in heavy duty scanning applications on cast iron. Interaction between the two materials can result in wear of the ruby ball's surface. For such applications, zirconia balls are recommended.

Name	Part number	Category	Ball dia. mm(in.)	Ball material	Length L1 mm(in.)	Stem material	EWL* L2 mm(in.)
M3-C21-NB2-S8	S-38-005	Straight	2.0(0.08)	Silicon nitride	21.0(0.83)	Tungsten carbide	8.0(0.31)
M3-C21-NB4-S17.2	S-38-008	Straight	4.0(0.16)	Silicon nitride	21.0(0.83)	Tungsten carbide	17.2(0.68)
M3-C30-NB2-S22.5	S-38-031	Straight	2.0(0.08)	Silicon nitride	30.0(1.18)	Tungsten carbide	22.5(0.89)
M3-P50-NB4-S46	S-38-070	Straight	4.0(0.16)	Silicon nitride	50.0(1.97)	Ceramic	46.0(1.81)
M3-F75-NB6-S75	S-38-080	Straight	6.0(0.24)	Silicon nitride	75.0(2.95)	Carbon fiber	75.0(2.95)



Name	Part number	Category	Ball dia. mm(in.)	Ball material	Length L1 mm(in.)	Stem material	EWL* L2 mm(in.)
M4-C20-NB2-S8	S-48-109	Straight	2.0(0.08)	Silicon nitride	20.0(0.79)	Tungsten carbide	8.0(0.31)
M4-S18-NB4-S13	S-48-116	Straight	4.0(0.16)	Silicon nitride	18.0(0.71)	Stainless steel	13.0(0.51)
M4-F50-NB6-S36	S-48-176	Straight	6.0(0.24)	Silicon nitride	50.0(1.97)	Carbon fiber	36.0(1.42)
M4-F100-NB6-S86	S-48-235	Straight	6.0(0.24)	Silicon nitride	100.0(3.94)	Carbon fiber	86.0(3.39)
M4-P60-NB5-S45	S-48-280	Straight	5.0(0.20)	Silicon nitride	60.0(2.36)	Ceramic	45.0(1.77)
M4-P60-NB6-S50	S-48-288	Straight	6.0(0.24)	Silicon nitride	60.0(2.36)	Ceramic	50.0(1.97)
M4-P80-NB6-S70	S-48-290	Straight	6.0(0.24)	Silicon nitride	80.0(3.15)	Ceramic	70.0(2.76)
M4-P100-NB6-S90	S-48-292	Straight	6.0(0.24)	Silicon nitride	100.0(3.94)	Ceramic	90.0(3.54)
M4-F120-NB6-S110	S-48-380	Straight	6.0(0.24)	Silicon nitride	120.0(4.72)	Carbon fiber	110.0(4.33)
M4-F160-NB6-S150	S-48-385	Straight	6.0(0.24)	Silicon nitride	160.0(6.3)	Carbon fiber	150.0(5.91)
M4-S70-NB6-S60	S-48-503	Straight	6.0(0.24)	Silicon nitride	70.0(2.76)	Bearing steel	60.0(2.36)
M4-S90-NB6-S80	S-48-505	Straight	6.0(0.24)	Silicon nitride	90.0(3.54)	Bearing steel	80.0(3.15)
M4-S110-NB6-S100	S-48-507	Straight	6.0(0.24)	Silicon nitride	110.0(4.33)	Bearing steel	100.0(3.94)
M4-S150-NB6-S140	S-48-511	Straight	6.0(0.24)	Silicon nitride	150.0(5.91)	Bearing steel	140.0(5.51)

Special ball materials: silicon nitride & zirconia

Name	Part number	Category	Ball dia. mm(in.)	Ball material	Length L1 mm(in.)	Stem material	EWL* L2 mm(in.)
M5-C20-NB2-S11	S-58-059	Straight	2.0(0.08)	Silicon nitride	20.0(0.79)	Tungsten carbide	11.0(0.43)
M5-C20-NB4-S11	S-58-071	Straight	4.0(0.16)	Silicon nitride	20.0(0.79)	Tungsten carbide	11.0(0.43)
M5-F50-NB6-S39	S-58-175	Straight	6.0(0.24)	Silicon nitride	50.0(1.97)	Carbon fiber	39.0(1.54)
M5-F100-NB6-S50	S-58-310	Straight	6.0(0.24)	Silicon nitride	100.0(3.94)	Carbon fiber	50.0(1.97)



Name	Part number	Category	Ball dia. mm(in.)	Ball material	Length L1 mm(in.)	Stem material	EWL* L2 mm(in.)
M3-C21-ZB2-S8	S-39-005	Straight	2.0(0.08)	Zirconia	21.0(0.83)	Tungsten carbide	8.0(0.31)
M3-C21-ZB4-S17.2	S-39-008	Straight	4.0(0.16)	Zirconia	21.0(0.83)	Tungsten carbide	17.2(0.68)
M3-C30-ZB2-S22.5	S-39-031	Straight	2.0(0.08)	Zirconia	30.0(1.18)	Tungsten carbide	22.5(0.89)
M3-P50-ZB4-S46	S-39-070	Straight	4.0(0.16)	Zirconia	50.0(1.97)	Ceramic	46.0(1.81)
M3-F75-ZB6-S75	S-39-080	Straight	6.0(0.24)	Zirconia	75.0(2.95)	Carbon fiber	75.0(2.95)



Name	Part number	Category	Ball dia. mm(in.)	Ball material	Length L1 mm(in.)	Stem material	EWL* L2 mm(in.)
M4-C20-ZB2-S8	S-49-109	Straight	2.0(0.08)	Zirconia	20.0(0.79)	Tungsten carbide	8.0(0.31)
M4-S18-ZB4-S13	S-49-116	Straight	4.0(0.16)	Zirconia	18.0(0.71)	Stainless steel	13.0(0.51)
M4-F50-ZB6-S36	S-49-176	Straight	6.0(0.24)	Zirconia	50.0(1.97)	Carbon fiber	36.0(1.42)
M4-F100-ZB6-S86	S-49-235	Straight	6.0(0.24)	Zirconia	100.0(3.94)	Carbon fiber	86.0(3.39)
M4-P60-ZB5-S45	S-49-280	Straight	5.0(0.20)	Zirconia	60.0(2.36)	Ceramic	45.0(1.77)
M4-P60-ZB6-S50	S-49-288	Straight	6.0(0.24)	Zirconia	60.0(2.36)	Ceramic	50.0(1.97)
M4-P80-ZB6-S70	S-49-290	Straight	6.0(0.24)	Zirconia	80.0(3.15)	Ceramic	70.0(2.76)
M4-P100-ZB6-S90	S-49-292	Straight	6.0(0.24)	Zirconia	100.0(3.94)	Ceramic	90.0(3.54)
M4-F120-ZB6-S110	S-49-380	Straight	6.0(0.24)	Zirconia	120.0(4.72)	Carbon fiber	110.0(4.33)
M4-F160-ZB6-S150	S-49-385	Straight	6.0(0.24)	Zirconia	160.0(6.3)	Carbon fiber	150.0(5.91)
M4-S70-ZB6-S60	S-49-503	Straight	6.0(0.24)	Zirconia	70.0(2.76)	Bearing steel	60.0(2.36)
M4-S90-ZB6-S80	S-49-505	Straight	6.0(0.24)	Zirconia	90.0(3.54)	Bearing steel	80.0(3.15)
M4-S110-ZB6-S100	S-49-507	Straight	6.0(0.24)	Zirconia	110.0(4.33)	Bearing steel	100.0(3.94)
M4-S150-ZB6-S140	S-49-511	Straight	6.0(0.24)	Zirconia	150.0(5.91)	Bearing steel	140.0(5.51)

Special ball materials: silicon nitride & zirconia

Name	Part number	Category	Ball dia. mm(in.)	Ball material	Length L1 mm(in.)	Stem material	EWL* L2 mm(in.)
M5-C20-ZB2-S11	S-59-059	Straight	2.0(0.08)	Zirconia	20.0(0.79)	Tungsten carbide	11.0(0.43)
M5-C20-ZB4-S11	S-59-071	Straight	4.0(0.16)	Zirconia	20.0(0.79)	Tungsten carbide	11.0(0.43)
M5-F50-ZB6-S39	S-59-175	Straight	6.0(0.24)	Zirconia	50.0(1.97)	Carbon fiber	39.0(1.54)
M5-F100-ZB6-S50	S-59-310	Straight	6.0(0.24)	Zirconia	100.0(3.94)	Carbon fiber	50.0(1.97)



Styli for Faro arms

These styli have been designed especially for use on Faro portable arm CMMs. Their robust design and construction utilizes balls made of Grade 5 Zirconia or ruby that have a high fracture toughness. The balls are bonded to the high strength tungsten carbide stem with impact resistant adhesive, and specialist construction techniques have been incorporated to ensure that the joint between the body and stem is extremely rigid and virtually indestructible.

1 1/4—20 UN thread styli

Part number	S-60-101 / Ruby	S-60-106 / Ruby	S-60-111 / Tungsten carbide
Ball dia. mm(in.)	3.0(0.12)	6.0(0.24)	
Length mm(in.)	57.0(2.24)	57.0(2.24)	57.0(2.24)



M6 threaded styli

Part number	S-60-121 / Ruby	S-60-126 / Ruby	S-60-131 / Zirconia	S-60-136 / Zirconia
Ball dia. mm(in.)	3.0(0.12)	6.0(0.24)	3.175(1/8in)	6.35(1/4in)
Length mm(in.)	43.0(1.69)	43.0(1.69)	43.0(1.69)	43.0(1.69)





WWW.PIONEERGROUP.COM.CN

PIONEER



HARBIN PIONEER M&E TECHNICAL DEVELOPMENT CO.,LTD

Add: 1F, Building 4, Tianping Road 22, Daoli District,
Harbin, China.

Tel: 0451-82330895 82293947

Fax: 0451-82293947 82285451

E-mail: sales@pioneergroup.com.cn

Postcode: 150078

